

HARDENED STEEL PRODUCTS

Faster, stronger
& better value



ActiBush

Trusted in New Zealand for over 30 years

Bushes, Pins, Hard Bar,
Seals & Shims,
Bosses & Sleeves

QUICK-START GUIDE

It's quick and easy to order custom pins and bushes, just add your dimensions to the relevant drawing, and email to sales@actibush.co.nz

Actibush will take care of the rest

Pg	Code & Information	Pg	Code & Information
 Bushes & Sleeves		 Round Tag Pins	
8	BR Bush with Radial Grooves Internal Radial Groove, External Radial Groove	19	OSB Round Tag 1x Bolt Hole, No Greaseway
9	BS Bush with Spiral Grooves Internal Spiral Groove, External Radial Groove	20	OSBGC Round Tag 1x Bolt Hole, 1x Greaseway
10	BIS Bush with Internal Spiral Internal Spiral Groove, No External Groove	21	OSBGGC Round Tag 1x Bolt Hole, 2x Greaseways
11	BSL Plain Bush/Sleeve No Internal Groove, No External Groove	 Rectangle Tag Pins	
 Top Hat Bushes		22	RS Rectangle Tag 1x Bolt Hole, No Greaseway
12	BTH Bush with Top Hat Plain Bush with Tophat / Flange	23	RSGC Rectangle Tag 1x Bolt Hole, 1x Greaseway
 No Tag, No Bolt Hole Pins		24	RSGGC Rectangle Tag 1x Bolt Hole, 2x Greaseways
13	N No Tag No Bolt Hole, No Greaseway	 Teardrop Tag Pins	
14	NGC No Tag No Bolt Hole, 1x Greaseway	25	TS Teardrop Tag 1x Bolt Hole, No Greaseway
15	NGGC No Tag No Bolt Hole, 2x Greaseway	26	TSGC Teardrop Tag 1x Bolt Hole, 1x Greaseway
 No Tag, Single Bolt Hole Pins		27	TSGGC Teardrop Tag 1x Bolt Hole, 2x Greaseways
16	NB No Tag 1x Bolt Hole, No Greaseway	 Locking Slot Pins	
17	NBGC No Tag 1x Bolt Hole, 1x Greaseway	28	L Locking Slot No Bolt Hole, No Greaseway
18	NBGGC No Tag 1x Bolt Hole, 2x Greaseways	29	LGC Locking Slot No Bolt Hole, 1x Greaseway
		30	LGGC Locking Slot No Bolt Hole, 2x Greaseways

HARD BAR

ActiBush stock a huge range of pre-hardened bar for customers ready to machine their own pins

Our hard bar is induction hardened, high tensile steel, purpose made for heavy machinery pins, available in metric and imperial sizes from 3/4" to 150mm

WHY USE ACTIBUSH HARD BAR INSTEAD OF HARD CHROME BAR?

- It's Stronger! - ActiBush hard bar is made from 4140 / 42CrMo high tensile steel which has a higher tensile strength
- It Lasts Longer! - Our hardened layer is thicker, so get more machine hours before replacement
- It's Versatile! - Our hard bar can be machined to suit your application. If you need a 70.85mm pin for your Hitachi, we've got you covered
- We Deliver Fast! - We work hard to make sure our orders get to you as soon as possible. Usually cut to length and dispatched same day by overnight courier

** Compared to 38MnVs6 Hard Chrome Bar

TAGS

ActiBush weld-on tags are pre cut and ready to weld
We stock a full range of round, teardrop, rectangle and keyhole tags for fast turn around pin builds. For more complex tags we can laser cut to suit any machine

PIN SEALS

Pin seals are pressed into the bush housing to create a barrier and keep dust and grime out of your bushes. All of our standard seals are made with polyurethane with a metal exterior, making them strong, flexible, and easy to install

If you are looking for a size not listed, ActiBush can source pin seals of almost any size, usually overnight, or we can get them custom made within a few days

SHIMS

Correctly fitting pins with shims to reduce sideways play and chatter is a must when fitting buckets and linkages to keep your machine running smoothly and reduce wear on key components

Cut from low carbon steel in a range of thicknesses, we can create custom shims to order if you don't see your size listed

PINS

High tensile core strength together with a hardened steel outer surface gives you one of the toughest hardest pins on the market - superior to most OEM products. Customer-proven to last 2-3 times longer!

ActiBush pins are made to order in New Zealand using high tensile steel bar stock, induction hardened to 55-62 HRC

See our enclosed pin drawings, or visit www.actibush.co.nz and use our custom pin builder to create pins for almost any machine

BUSHES (8000 bushes in stock over 250 sizes)

ActiBush bushes are made from quality steel and case hardened to 55-62 HRC to ensure a longer life and trouble free operation. Cut to precise tolerances they allow a firm press fit and precise clearance for smooth operation

Can't find your size?

ActiBush can modify the OD, ID or length of any stock bush to suit almost any machine usually within 1-2 working days

Custom Bushes

ActiBush make custom hardened steel and bronze bushes to order, right here in New Zealand. Whether it's a top hat bush, heavy walled bush for line boring, large bushes for heavy rated machines, we make them accurately, cost-effectively, and fast! Usually within 6-8 working days

BOSSES

Non-hardened, weld in bosses, custom machined to order. Contact us with your requirements and we will put together a quote

STATIC SLEEVES

Our sleeves are designed for holding a static pin. Case hardened and precision machined for a tighter static fit. Use these on the non rotating parts of the machine to reduce wear and save on future line boring

LOCK COLLARS

Just weld on an bolt up. A cost effective way to secure hardened steel pins to buckets and machinery



WHY CHOOSE ACTIBUSH

Unexpected breakages don't need to create stressful downtime for your machines, business and bottom line. ActiBush has the processes and parts in place to get you back to full capacity, **FAST**

- STEP 1:** Send us the damaged part dimensions
We've made that simple with our easy-to-use templates - or just give us a call and we'll walk you through it
- STEP 2:** We'll machine the part - fast
Our pre-hardened stock means we can get to work as soon as your measurements are in
- STEP 3:** You get your part express-shipped
Once complete, parts will be sent by overnight courier, so you can get back up and running sooner

ActiBush was founded to solve a simple problem: getting reliable replacement parts for heavy-duty equipment quickly and locally. Active Engineering Ltd, our sister company, struggled to source original parts and found many imported aftermarket items failed early. Long heat-treatment times also made same-day repairs impossible, causing costly delays

To ensure fast access to hardened bushes that often outlast genuine parts, we began producing common sizes in-house. That range quickly grew into a comprehensive selection that meets the needs of all types of machinery. As our products became sought after by other repair companies, ActiBush became an independent, trusted local supplier

Today we supply bushes, pins, and tags across New Zealand, known for our durable parts that deliver long-term reliability. We prioritise great value, rapid turnaround, and a dependable local relationships built on trust

Our expanding range of pins and bushes can be tailored to your needs. Because of our close relationship with heat-treatment facilities here in New Zealand, as well as raw products stocked in-house, we can produce custom options quickly so you don't wait. Investment in skilled staff and modern equipment means we're a reliable, local source of spare parts and materials ready to get your machines up and working fast!

BUSH & PIN ORDER TEMPLATES

CUSTOM PARTS DONE FAST

We've made custom orders easy

1. Find the page that best matches your damaged part, or download less common variations from our website - actibush.co.nz/custom-pins
2. Write the measurements on the sheet, then email us a photo or a scan to sales@actibush.co.nz
3. We'll be in touch to confirm sizing, then get to work quickly on your replacement

∞ Drawing Code:

BR

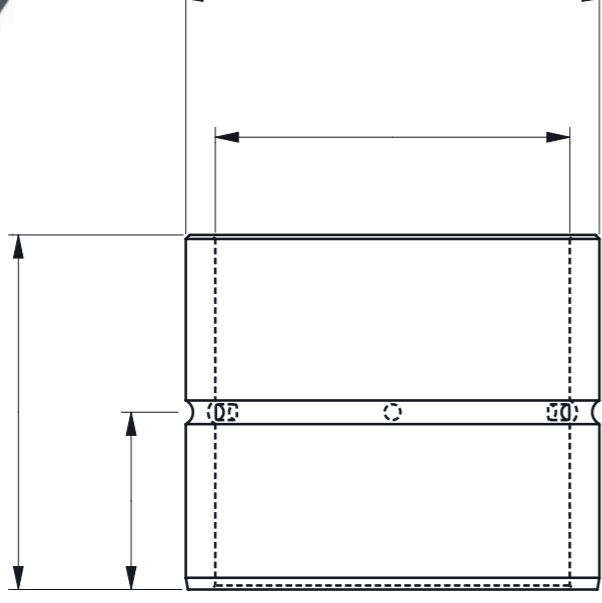
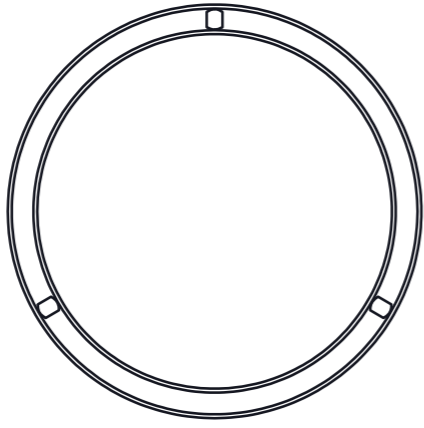
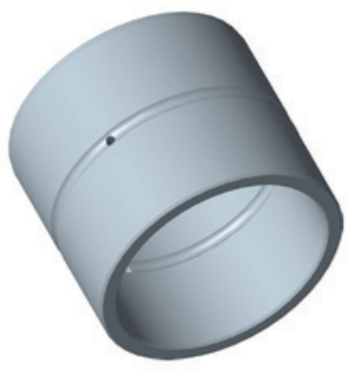

ActiBush

Quantity:		Customer Name	
Hardened:	<input type="checkbox"/>	Customer Order #	

Email: sales@actibush.co.nz

Phone: **09 475 9816**

actibush.co.nz

∞ Drawing Code:

BS

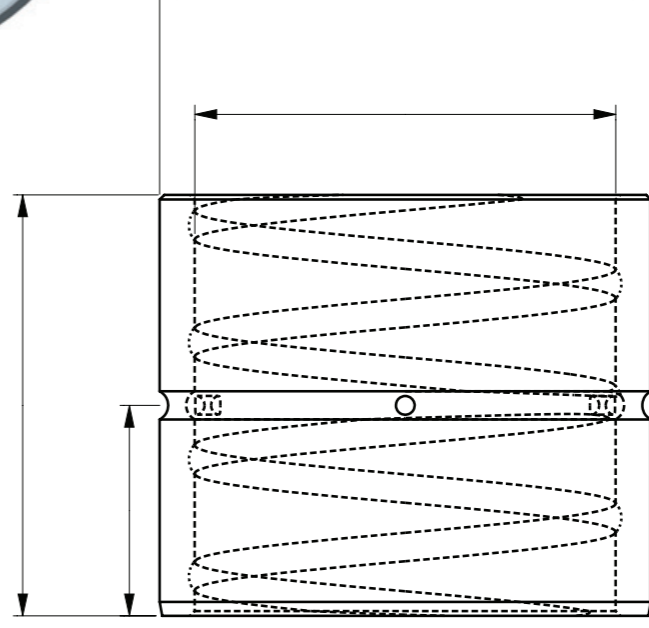
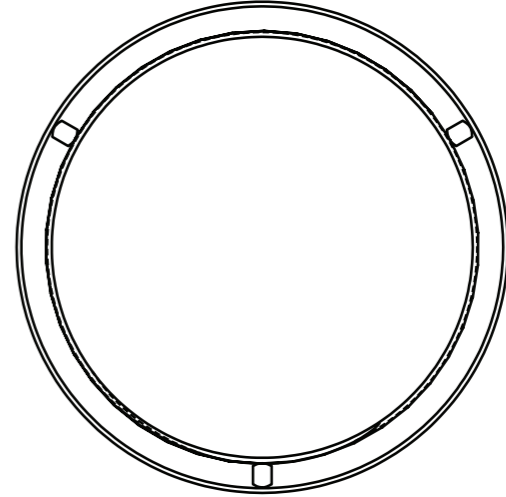
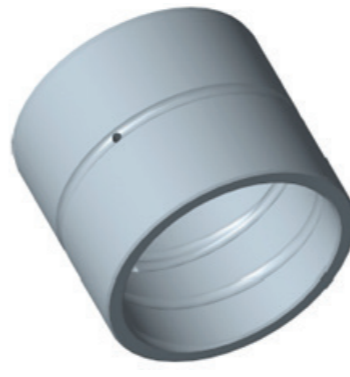

ActiBush

Quantity:		Customer Name	
Hardened:	<input type="checkbox"/>	Customer Order #	

Email: sales@actibush.co.nz

Phone: **09 475 9816**

actibush.co.nz

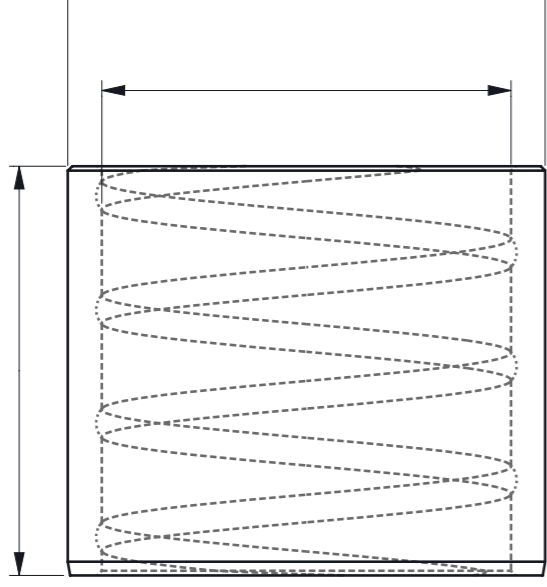
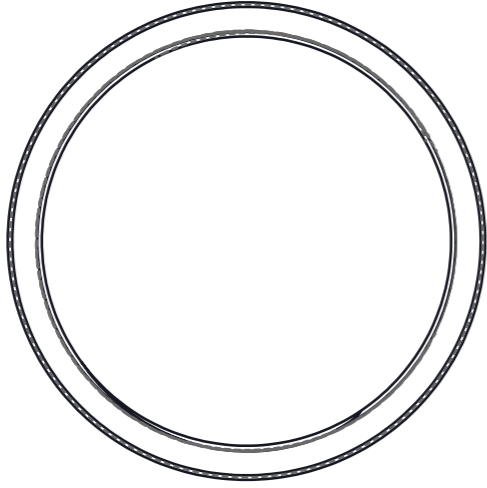

ActiBush

Quantity:		Customer Name	
Hardened:	<input type="checkbox"/>	Customer Order #	

Email: sales@actibush.co.nz

Phone: **09 475 9816**

actibush.co.nz

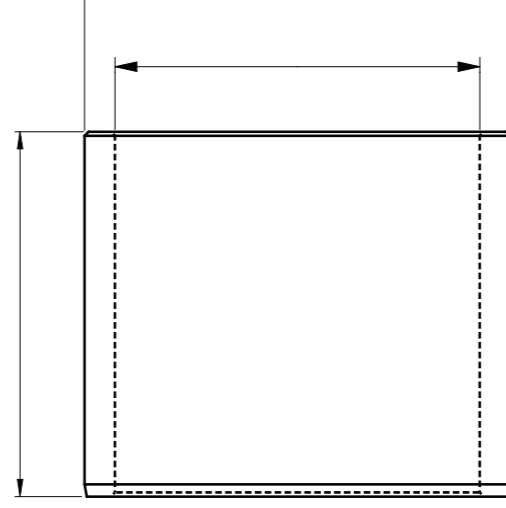
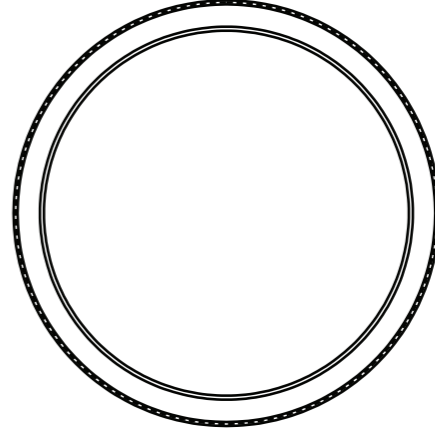
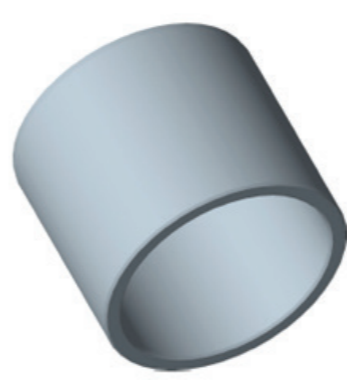

ActiBush

Quantity:		Customer Name	
Hardened:	<input type="checkbox"/>	Customer Order #	

Email: sales@actibush.co.nz

Phone: **09 475 9816**

actibush.co.nz

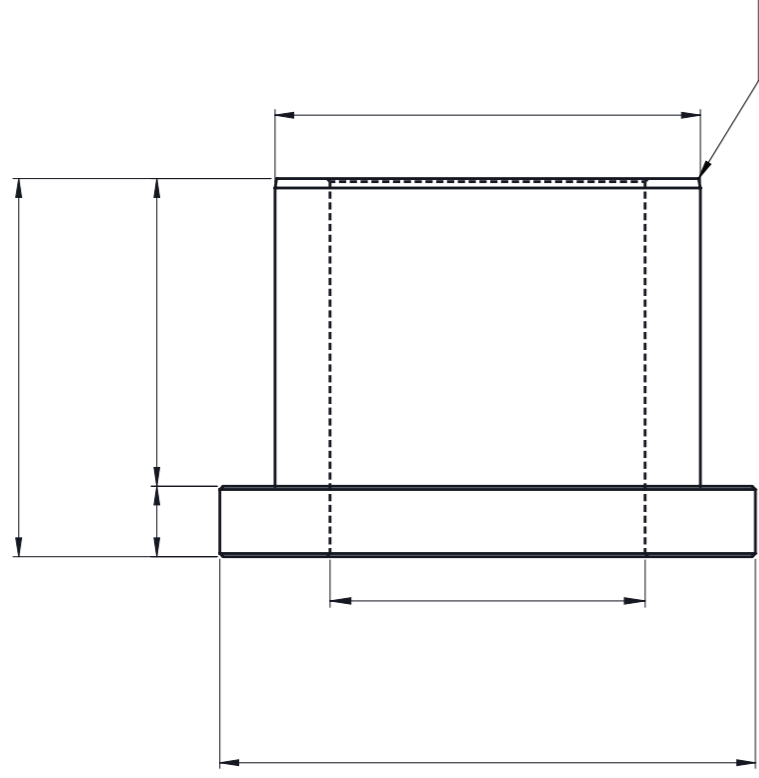
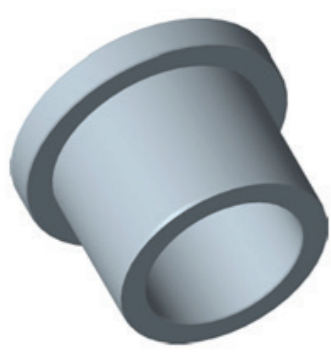

Quantity:		Customer Name	
Hardened:	<input type="checkbox"/>	Customer Order #	

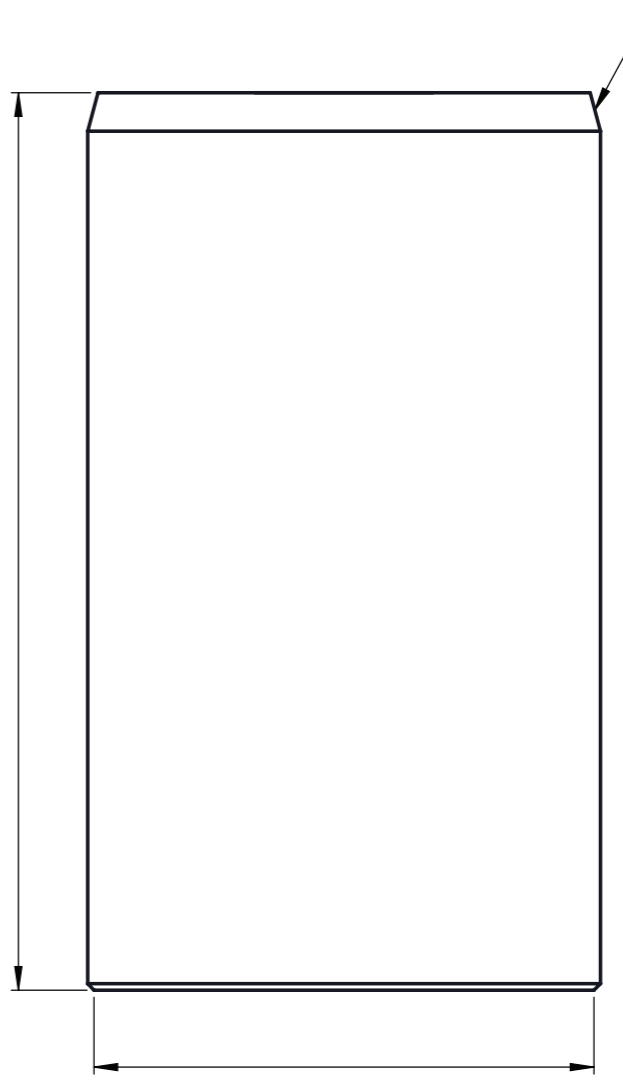
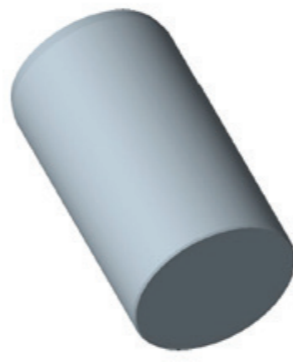
Email: sales@actibush.co.nzPhone: **09 475 9816**actibush.co.nz

Quantity:		Customer Name	
Hardened:	<input type="checkbox"/>	Customer Order #	

Email: sales@actibush.co.nzPhone: **09 475 9816**actibush.co.nz

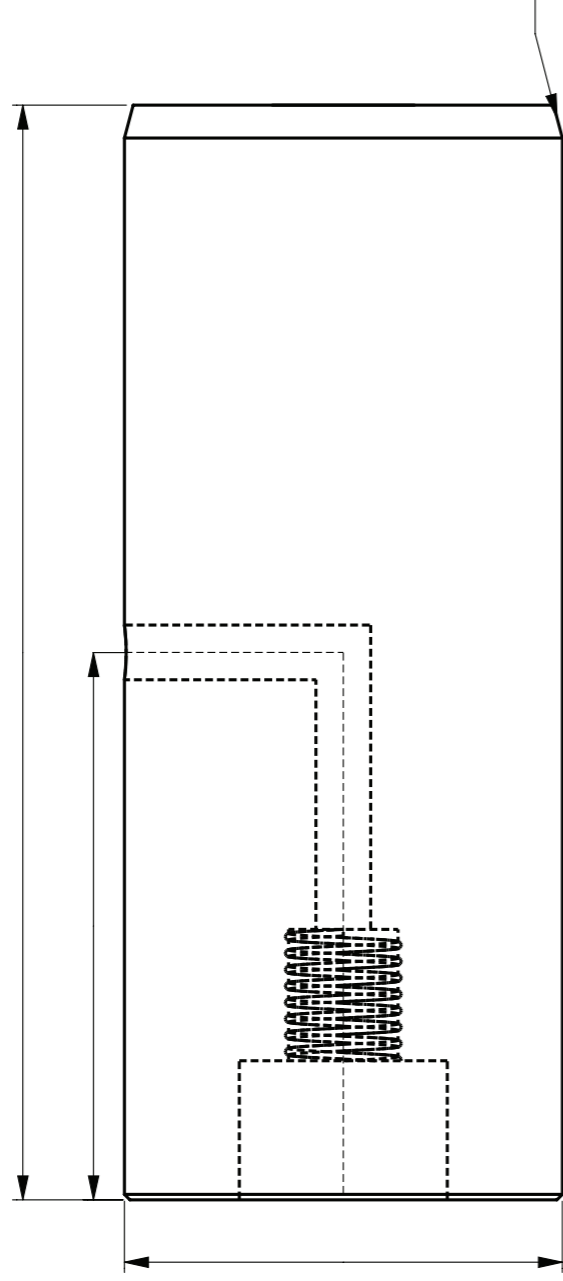

ActiBush

Quantity:	Customer Name
Hardened: <input type="checkbox"/>	Customer Order #

Email: sales@actibush.co.nz

Phone: **09 475 9816**

actibush.co.nz

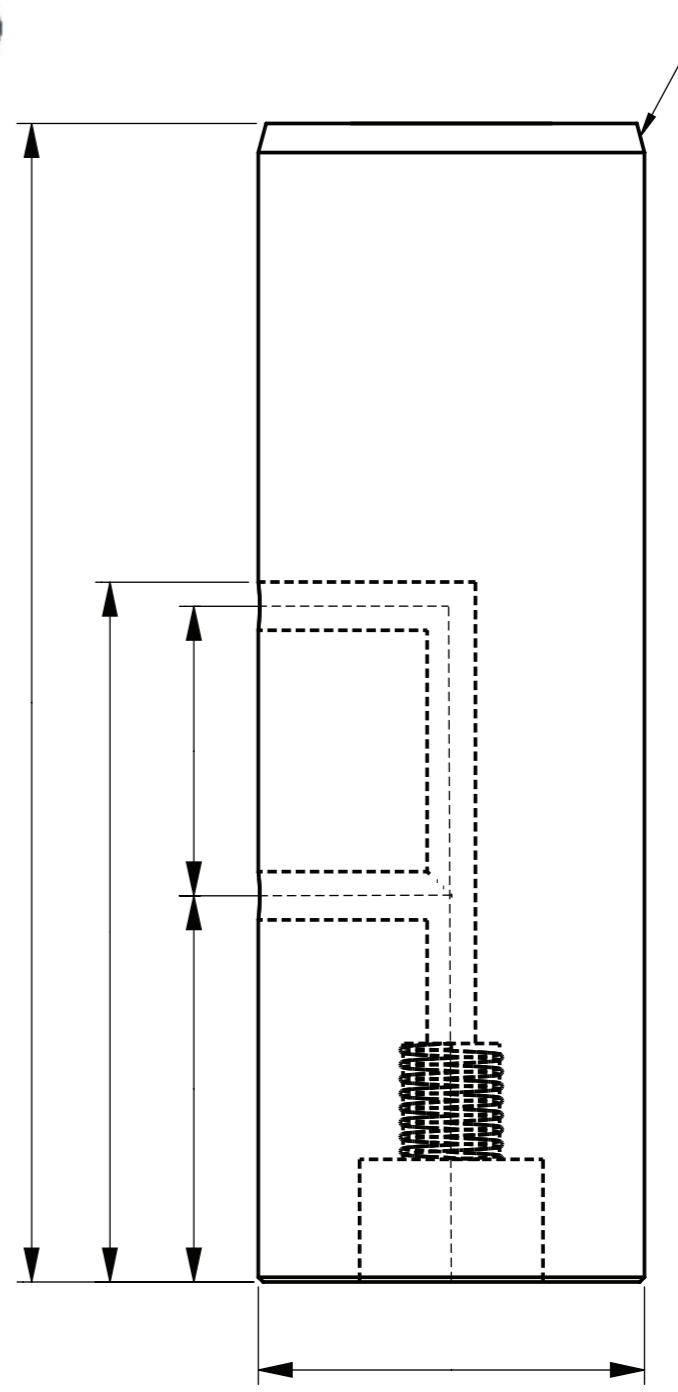

ActiBush

Quantity:	Customer Name
Hardened: <input type="checkbox"/>	Customer Order #

Email: sales@actibush.co.nz

Phone: **09 475 9816**

actibush.co.nz

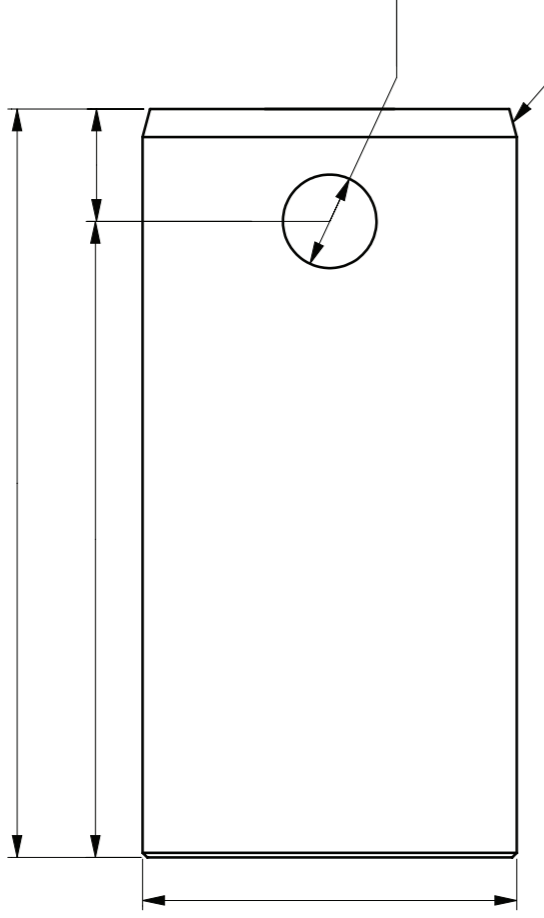
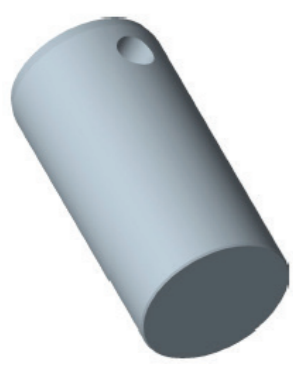

Quantity:		Customer Name	
Hardened:	<input type="checkbox"/>	Customer Order #	

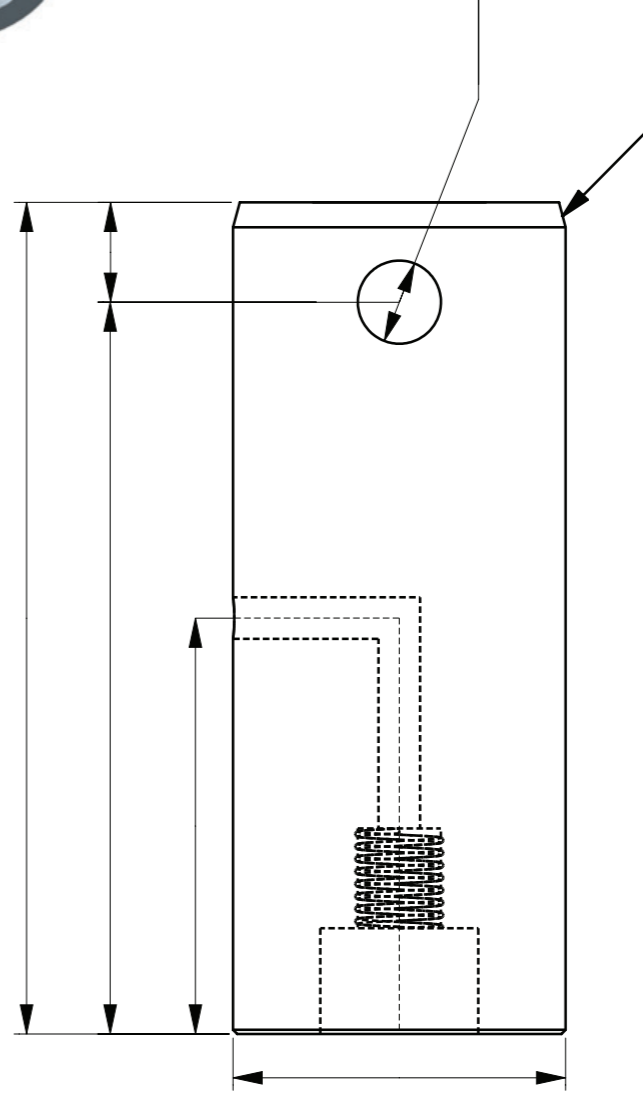
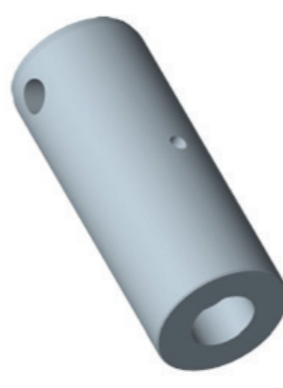

Quantity:		Customer Name	
Hardened:	<input type="checkbox"/>	Customer Order #	

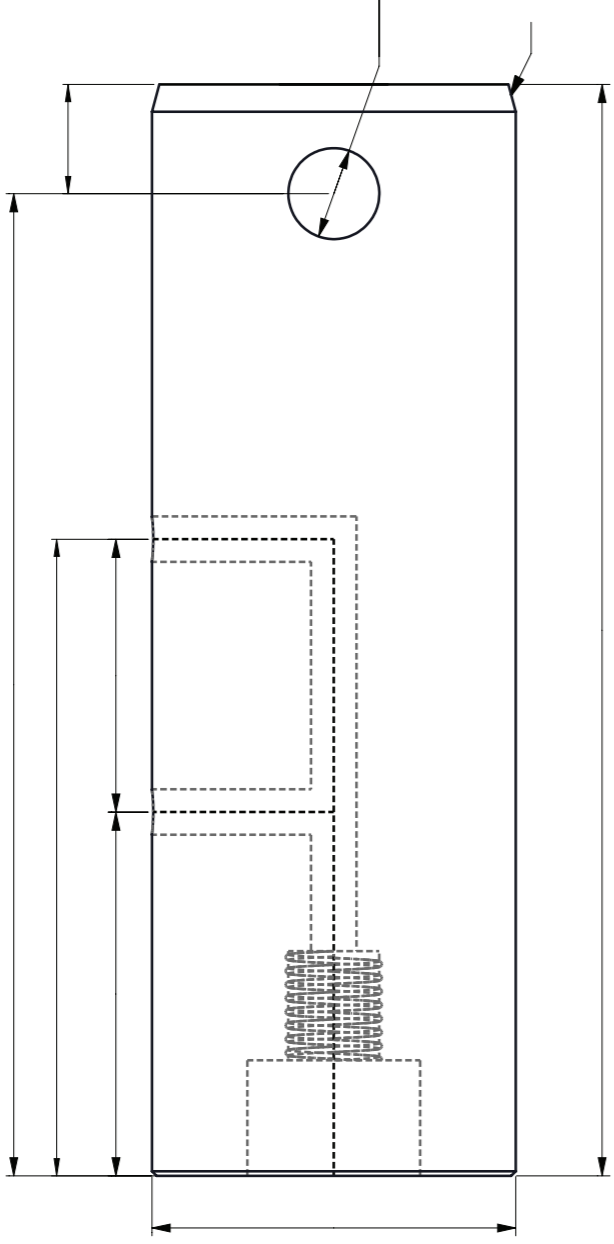
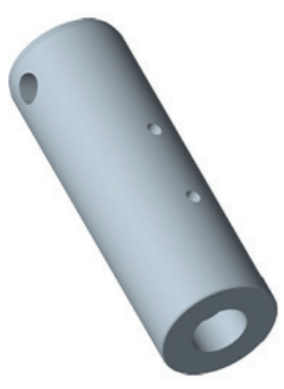

ActiBush

Quantity:	Customer Name
Hardened: <input type="checkbox"/>	Customer Order #

Email: sales@actibush.co.nz

Phone: **09 475 9816**

actibush.co.nz

Drawing Code:

OSB

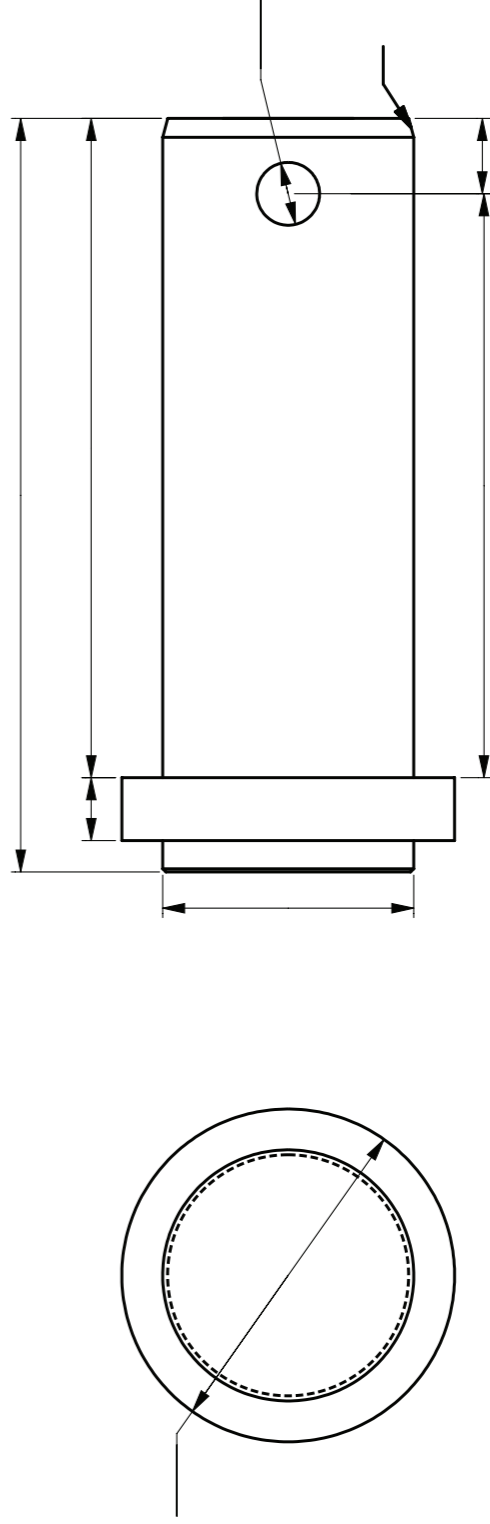
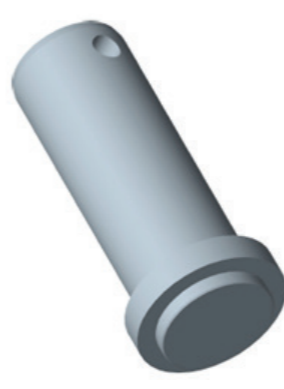

ActiBush

Quantity:	Customer Name
Hardened: <input type="checkbox"/>	Customer Order #

Email: sales@actibush.co.nz

Phone: **09 475 9816**

actibush.co.nz

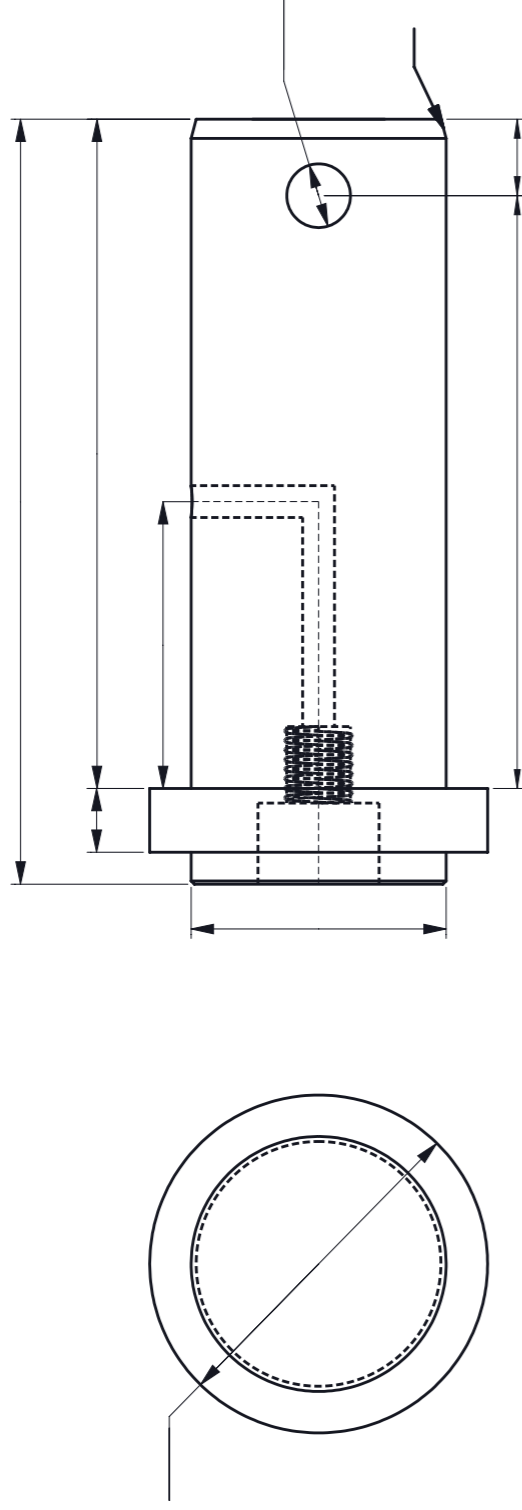

ActiBush

Quantity:

Hardened:

Customer Name

Customer Order #

Email: sales@actibush.co.nz

Phone: **09 475 9816**

actibush.co.nz

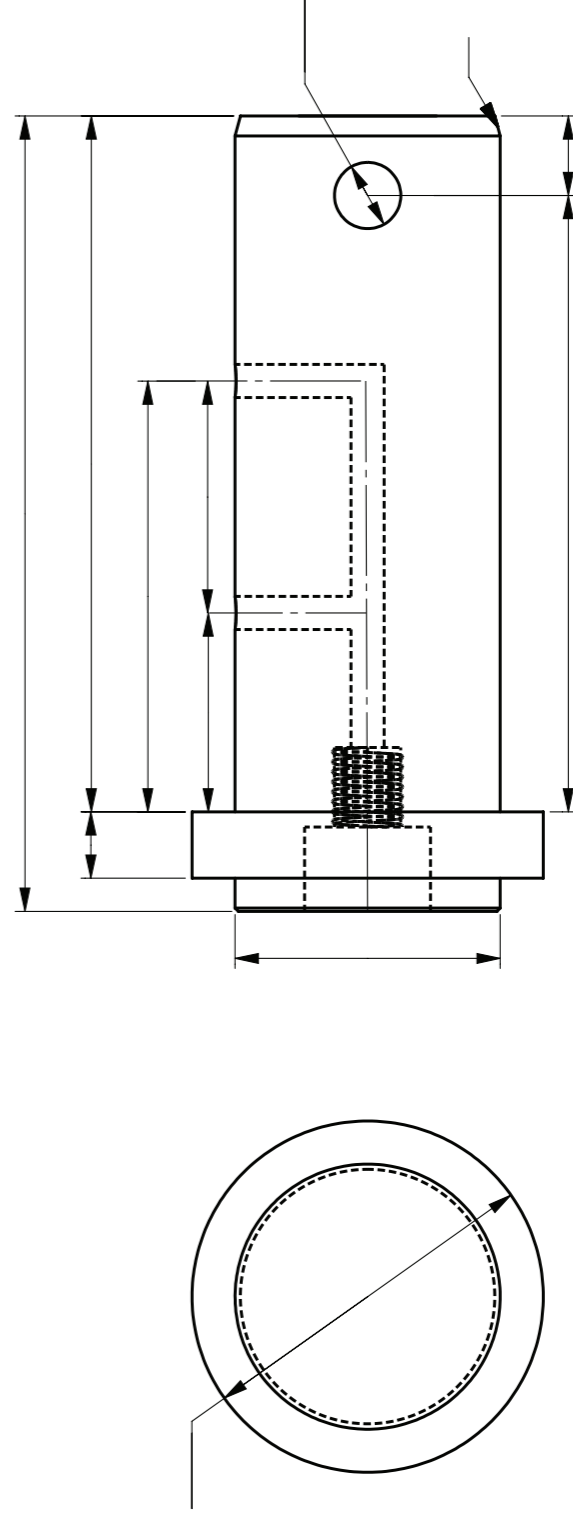

ActiBush

Quantity:

Hardened:

Customer Name

Customer Order #

Email: sales@actibush.co.nz

Phone: **09 475 9816**

actibush.co.nz

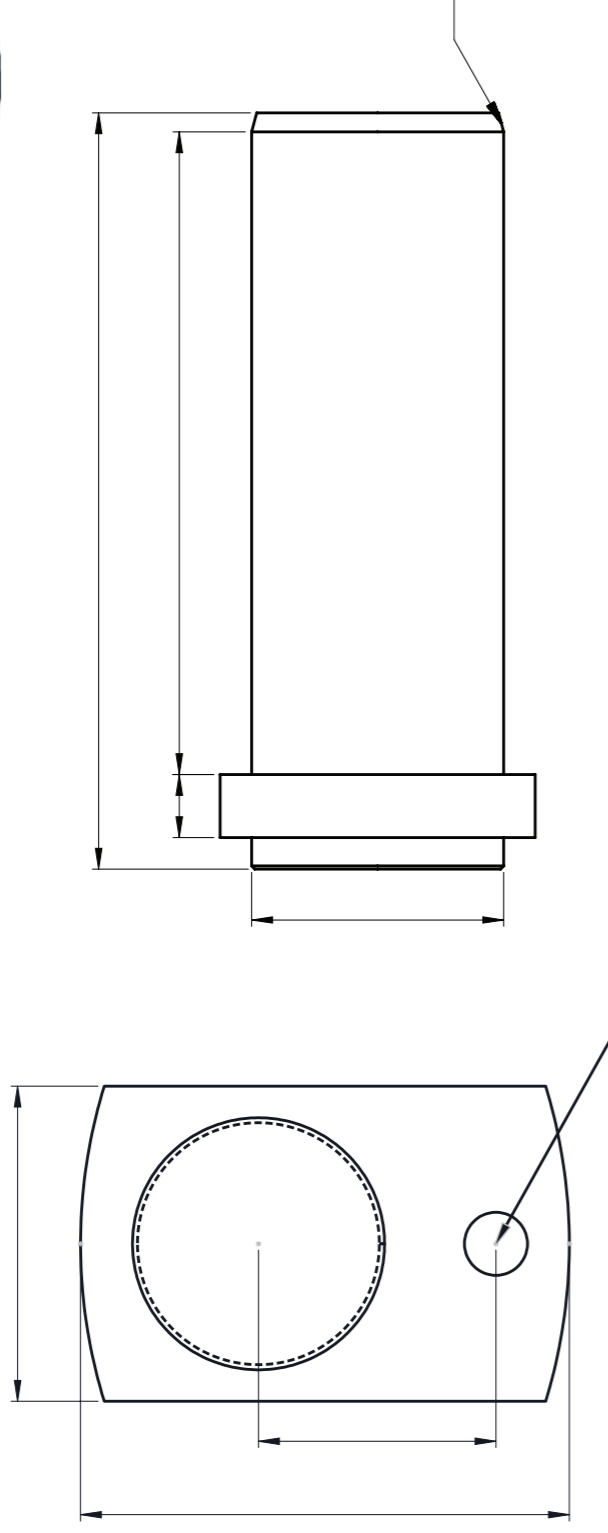

ActiBush

Quantity:	<input type="text"/>	Customer Name	<input type="text"/>
Hardened:	<input type="checkbox"/>	Customer Order #	<input type="text"/>

Email: sales@actibush.co.nz

Phone: **09 475 9816**

actibush.co.nz

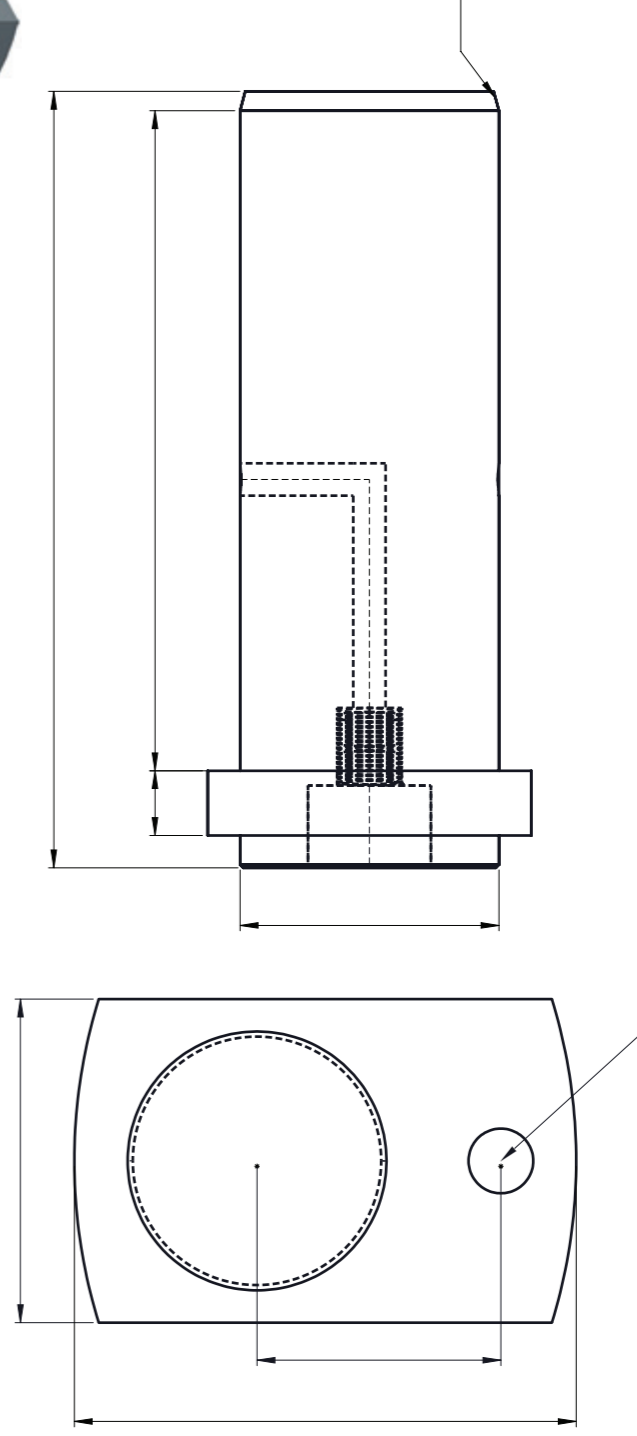

ActiBush

Quantity:	<input type="text"/>	Customer Name	<input type="text"/>
Hardened:	<input type="checkbox"/>	Customer Order #	<input type="text"/>

Email: sales@actibush.co.nz

Phone: **09 475 9816**

actibush.co.nz

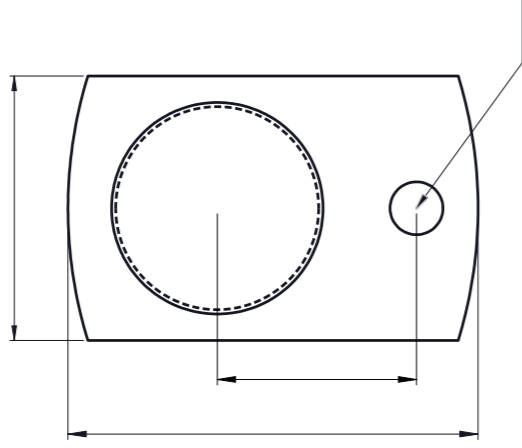
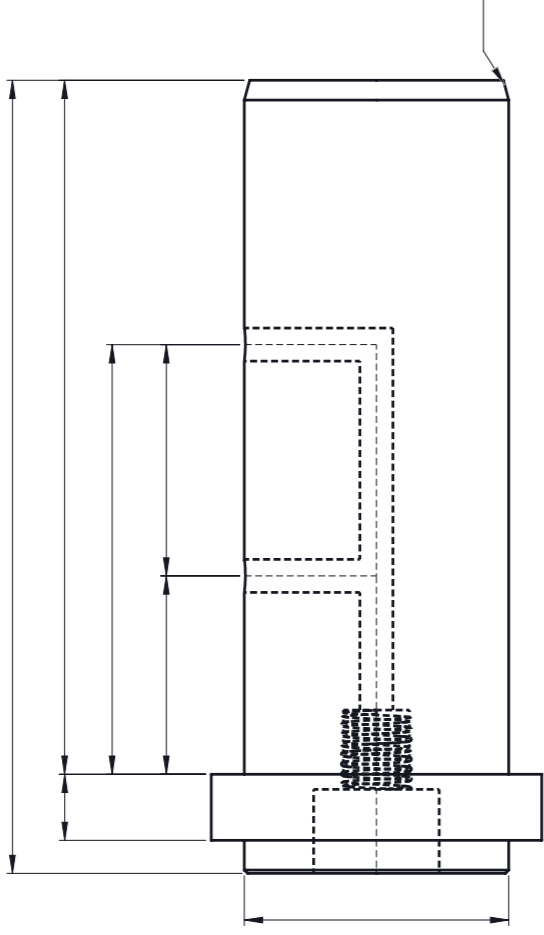

ActiBush

Quantity:	Customer Name
Hardened: <input type="checkbox"/>	Customer Order #

Email: sales@actibush.co.nz

Phone: **09 475 9816**

actibush.co.nz

Drawing Code:

TS

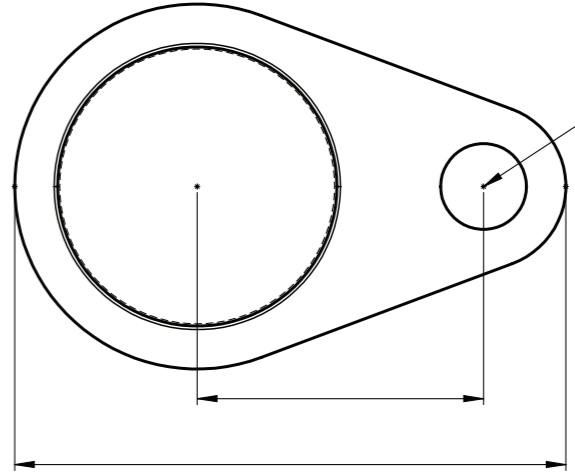
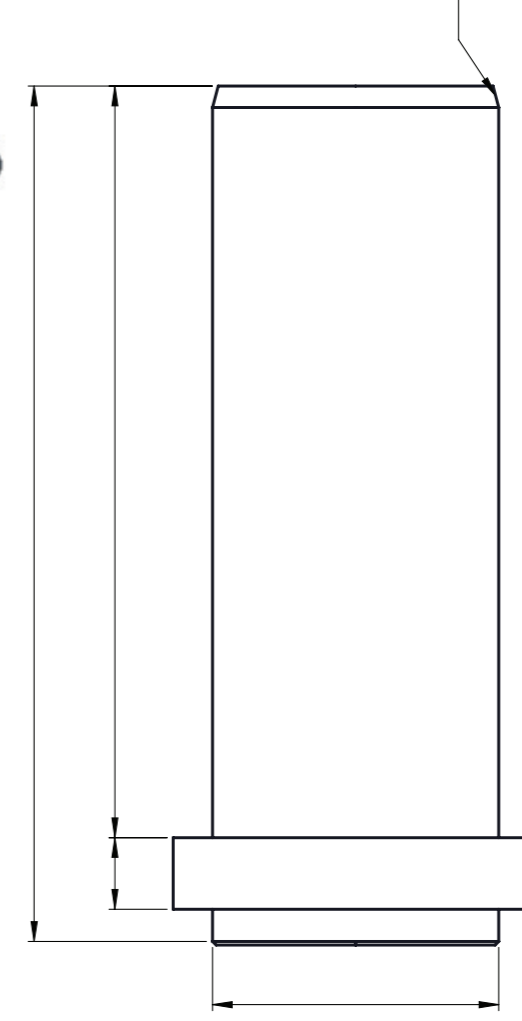

ActiBush

Quantity:	Customer Name
Hardened: <input type="checkbox"/>	Customer Order #

Email: sales@actibush.co.nz

Phone: **09 475 9816**

actibush.co.nz

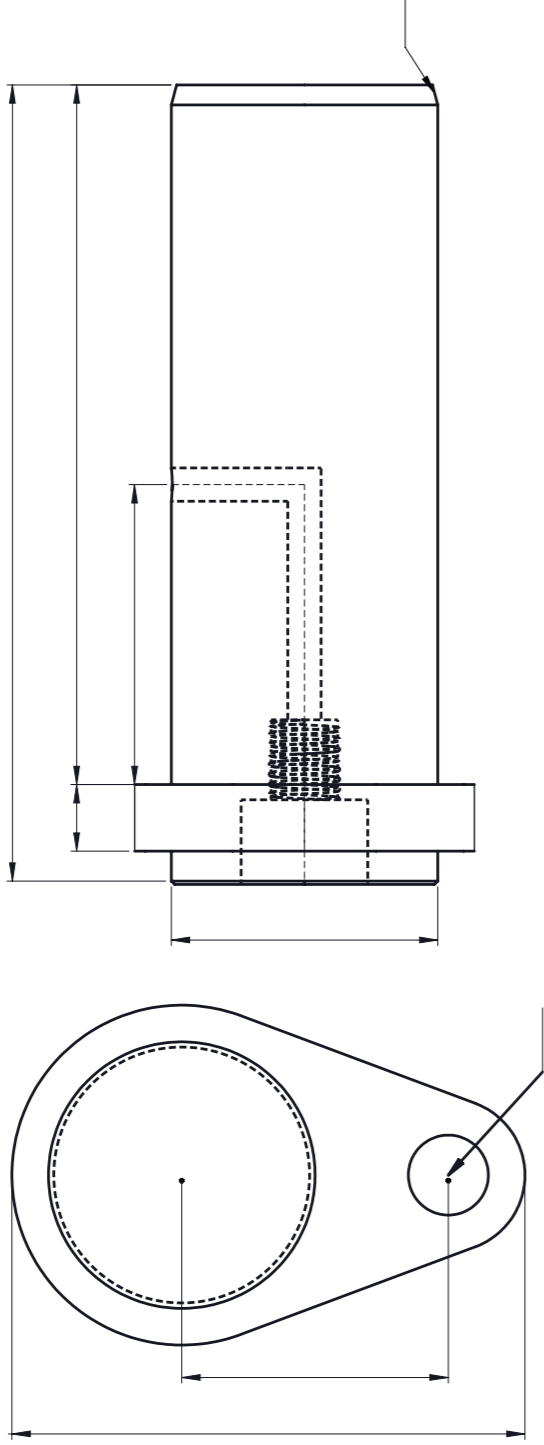

ActiBush

Quantity:		Customer Name	
Hardened:	<input type="checkbox"/>	Customer Order #	

Email: sales@actibush.co.nz

Phone: 09 475 9816

actibush.co.nz

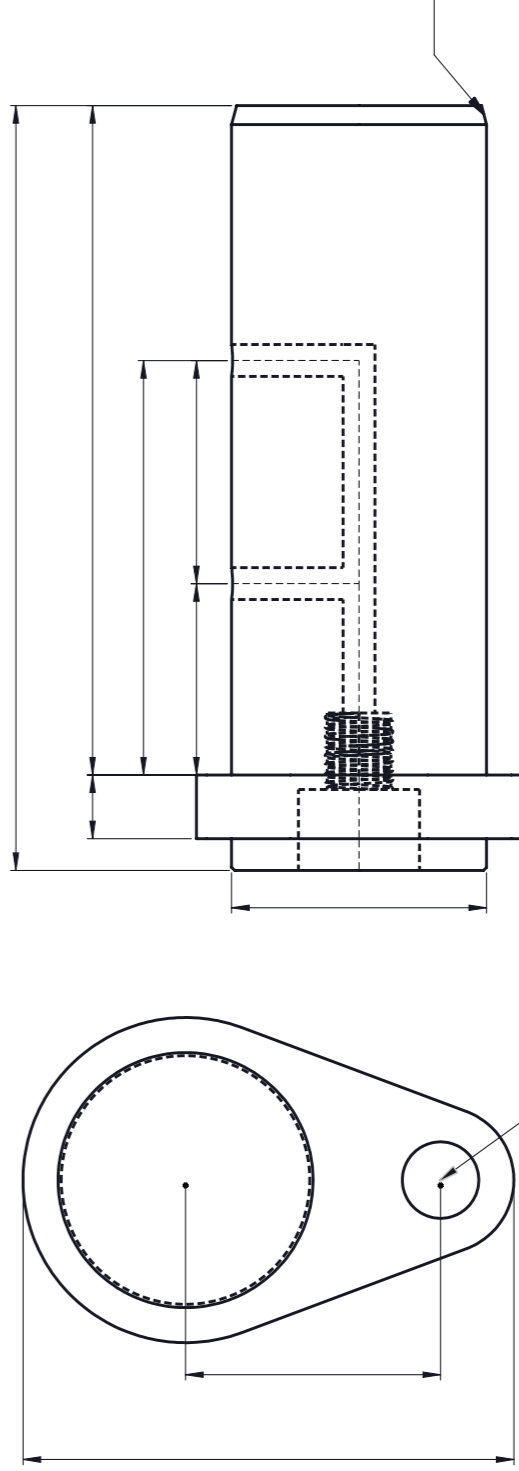

ActiBush

Quantity:		Customer Name	
Hardened:	<input type="checkbox"/>	Customer Order #	

Email: sales@actibush.co.nz

Phone: 09 475 9816

actibush.co.nz

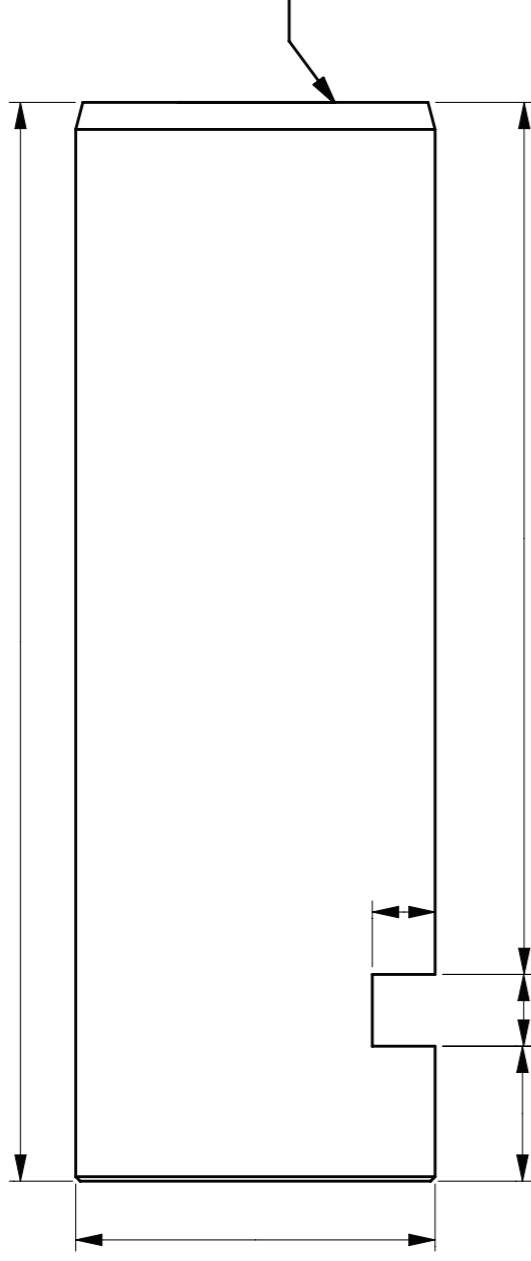
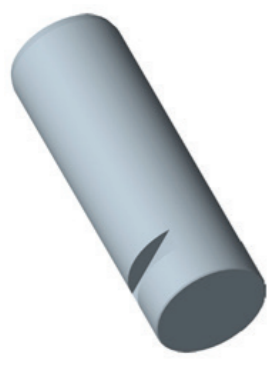

ActiBush

Quantity:

Hardened:

Customer Name

Customer Order #

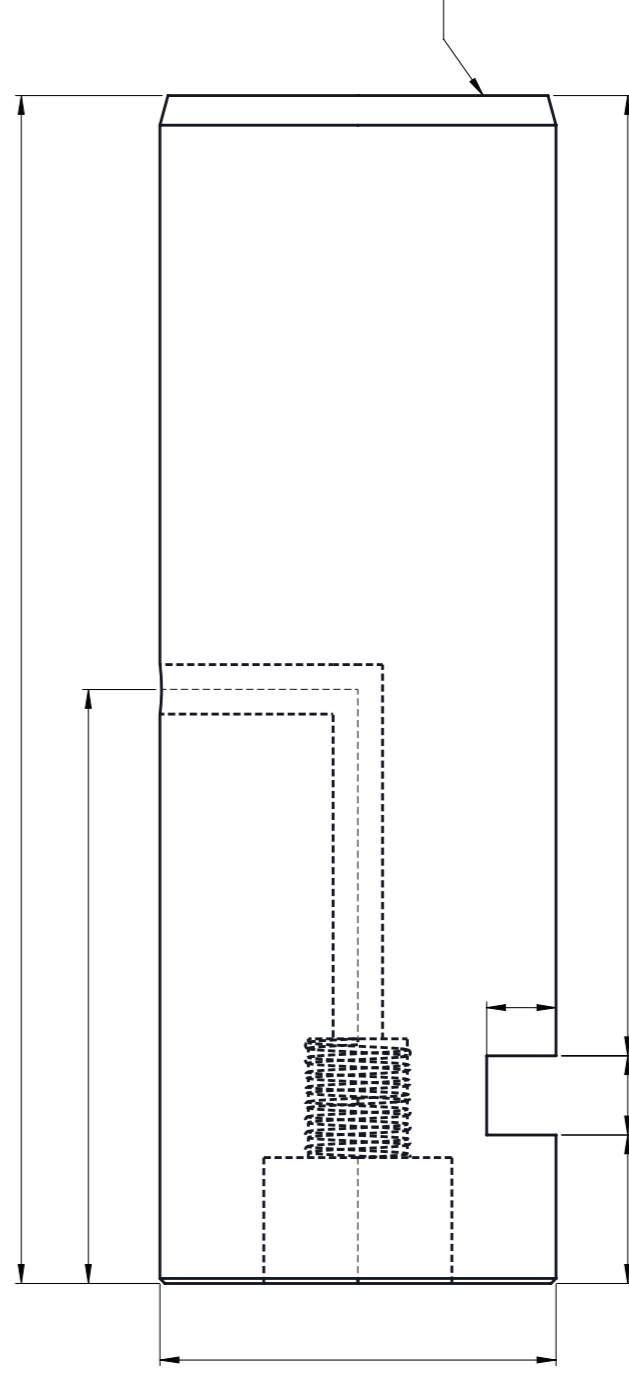
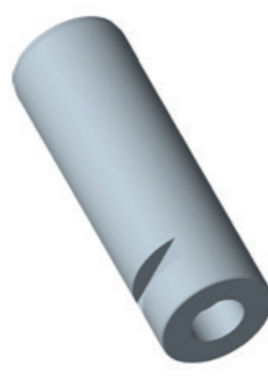
Email: sales@actibush.co.nzPhone: **09 475 9816**actibush.co.nz

ActiBush

Quantity:

Hardened:

Customer Name

Customer Order #

Email: sales@actibush.co.nzPhone: **09 475 9816**actibush.co.nz

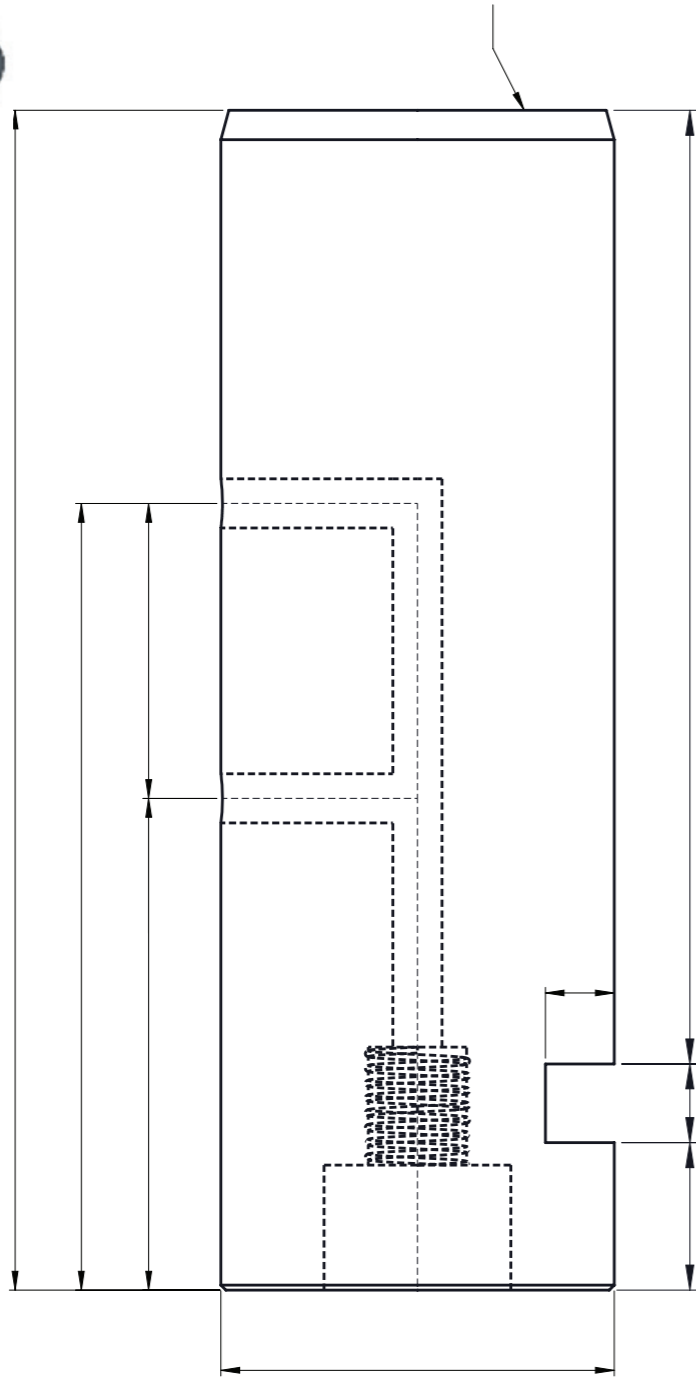
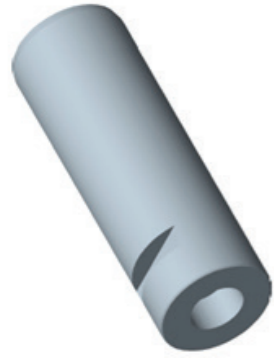

Quantity:	<input type="text"/>	Customer Name	<input type="text"/>
Hardened:	<input type="checkbox"/>	Customer Order #	<input type="text"/>

Email: sales@actibush.co.nz

Phone: **09 475 9816**

actibush.co.nz

DON'T JUST TAKE OUR WORD FOR IT

With over 30 years of experience, here are just a few of the things machine owners like you had to say about ActiBUSH

*ActiBUSH is fantastic to work with. Great product, always happy to help, work through custom products and **they make the process really easy.** Highly recommended!*

Caleb Waugh | Porter Mechanical



*We have consistently chosen ActiBUSH because **their range of products and services is truly exceptional.** They continually go above and beyond, often going the extra mile to provide custom solutions that meet the unique needs of both our company and our customers*

Luke Garland | Shaws



*As a break down and repair company, a fast turn-around is essential to our business. **Their quality and accuracy of their products are second to none.** After 14 years of using Acti-Bush I wouldn't go anywhere else!*

Gary Whitehead | Hardisty Engineering



When line-boring in the field it is great to be able to contact the team at Acti-Bush who have the knowledge and experience to deal with my requirements to complete my job

*At the end of the day this adds up to a **cost effective, time saving way to get the job done for clients***

Tony Parker | Mobile Machining Services



OUR PRODUCTS

Hardened bushes and sleeves now with an even wider range of sizes in stock

Hardened, high tensile steel pin stock, ready to go for fast turnaround of pins

Weld on tags, lock collars, pin seals and shims always in stock

Customised bushes, bosses and pins made to order

OUR ADVANTAGE

Faster delivery times get your machinery back to work sooner

Local stock, local delivery and local support

Long lasting products ensure you get more running time before replacement

Buy with confidence when you deal with an experienced, trustworthy and reliable New Zealand business

If you have any questions please email us at sales@actibush.co.nz and our friendly staff will be there to help!

Thanks again for joining our customer family.
We appreciate your business



ActiBush

Trusted in New Zealand for over 30 years

sales@actibush.co.nz

09 475 9816

actibush.co.nz